

Article number: 20240643530E

Description: E+G Telescope-Lear motion bearings GN 2406-43-530-E

## Measures

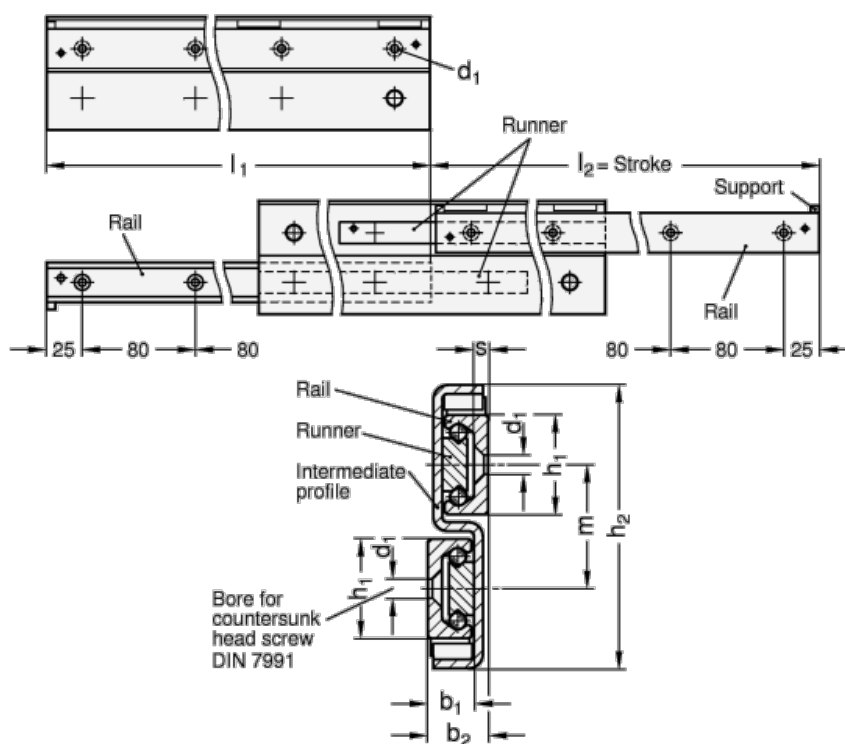

$b_1 = 21$

$b_2 = 28$

$d_1 = 8.5$

$h_1 = 43$

$h_2 = 117$

$L_1 = 530 - 556$

$m = 52$

$s = 4.5$

Weight in (g) = 7740